

# ASSEMBLY AND INSTALLATION INSTRUCTIONS

T0561

**WARNING: Turn off the main power at circuit breaker before installing fixture.**  
**AVERTISSEMENT: Coupez la source d'alimentation principale au panneau central de disjoncteurs avant d'installer le luminaire.**

**NOTE: 1. Before installing, consult local electrical codes for wiring and grounding requirements.**  
**2. READ AND SAVE THESE INSTRUCTIONS.**

## Hardware Package (included):

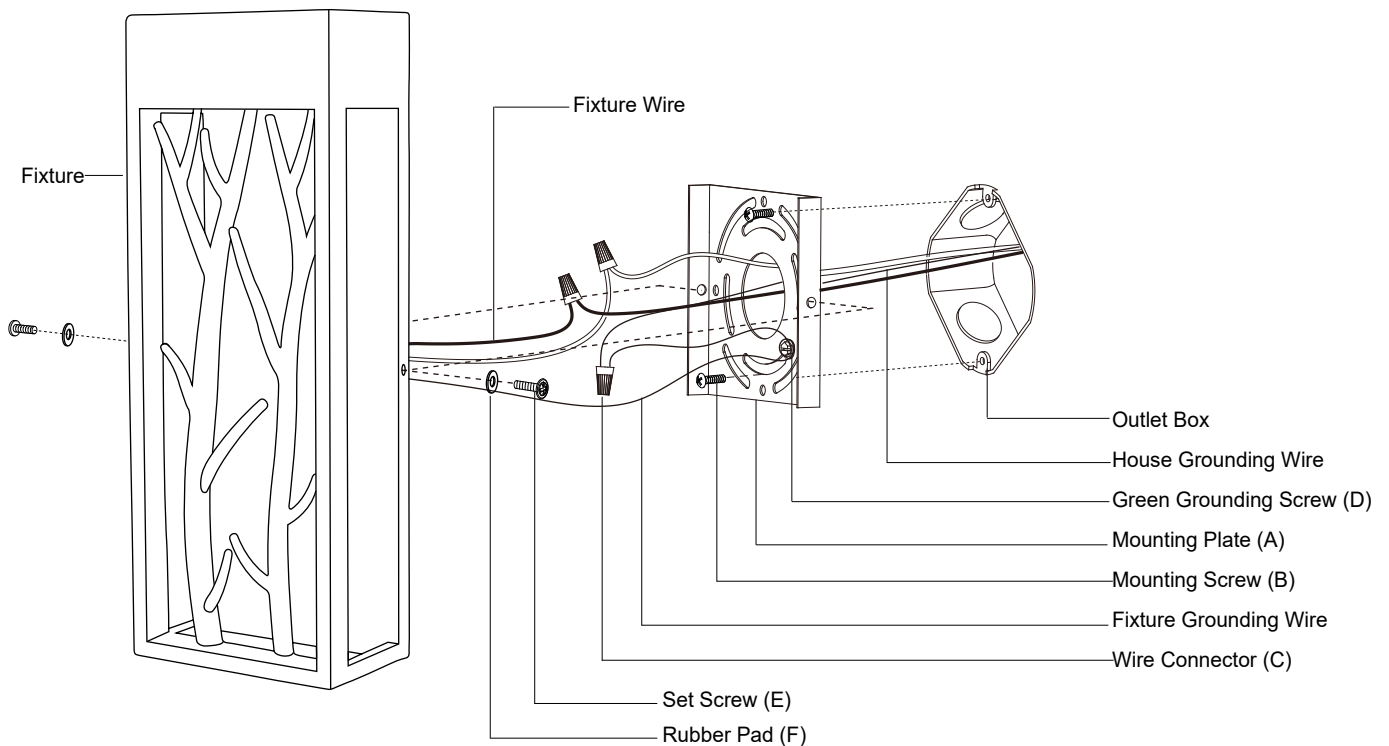
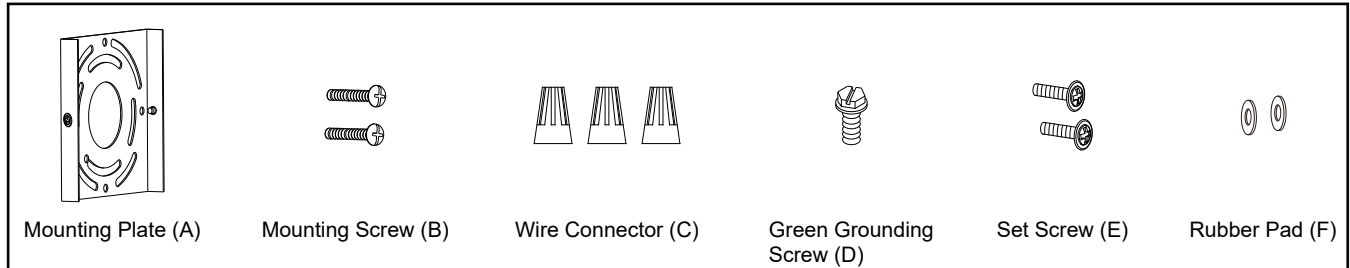

## Installation Steps

Turn off the power at fuse or circuit box.

1. Remove the two set screws (E), the two rubber pads (F) and the mounting plate (A) from the fixture.
2. Attach mounting plate (A) to the outlet box using two mounting screws (B).

3. Pull out the source wires from the outlet box. Make wire connections using wire connectors (C) as follows:
  - Connect the hot wire (usually black insulation) from the fixture to the black wire from the power source.
  - Connect the neutral wire (usually white insulation) from the fixture to the white wire from the power source.
  - Attach the fixture grounding wire (usually green insulation or bare wire) to the mounting plate (A) with the green grounding screw (D), then connect it to the house grounding wire with the wire connector (C).
 Carefully put all of the wires back into the outlet box.
4. Attach the fixture to the mounting plate (A), then secure it with the two rubber pads (F) and the two set screws (E).

**Turn on the power at fuse or circuit box.**

The following parts are available for re-order if damaged or missing.

**Spare Parts List:**



Mounting Plate (A)



Mounting Screw (B)

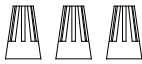

Wire Connector (C)



Green Grounding Screw (D)



Set Screw (E)



Rubber Pad (F)

↑ Assembly Kit  
6191MM (1 SET)

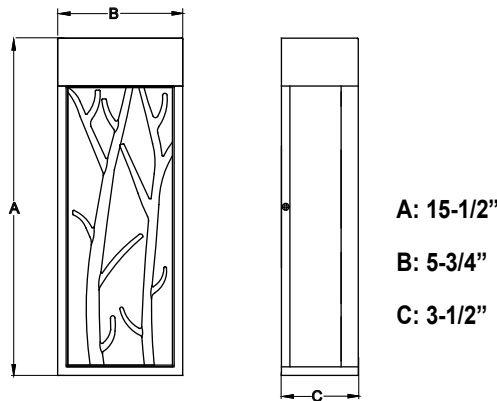

### 5 Year Limited Warranty

Vaxcel warrants all of our products against defects in workmanship and finishes for one year following the date of shipment.

In addition:

- Any product with an integrated motion sensor or dusk-to-dawn photocell is supported by a 5-year warranty for the functionality of the product.
- Any product with integrated LED modules is covered by a 5-year warranty on the LED functionality.

*Exclusions: This warranty does not include the failure of products from extreme acts of nature; environmental conditions not suited for the products intended use; operation in temperatures outside of the range specified in the instruction manual; usage with improper power supply, power surges or dips. For coastal locations, some corrosion is considered normal for the environment.*

*Vaxcel reserves the right to repair, replace or issue a credit for any properly installed product, provided it is returned per RMA instruction. This warranty is limited to the cost of the product only and does not extend to transportation, installation or replacement costs.*

How can warranty service be obtained?  
[info@vaxcel.com](mailto:info@vaxcel.com)  
 1-800-482-9235