

# ASSEMBLY AND INSTALLATION INSTRUCTIONS

C0077

**WARNING:** TO AVOID RISK OF ELECTRICAL SHOCK, BE SURE TO SHUT OFF POWER WHILE INSTALLING OR SERVICING THIS FIXTURE.

**NOTES:** 1. Before installing, consult local electrical codes for wiring and grounding requirements.  
2. Read and save these instructions.

## Hardware Package (included):

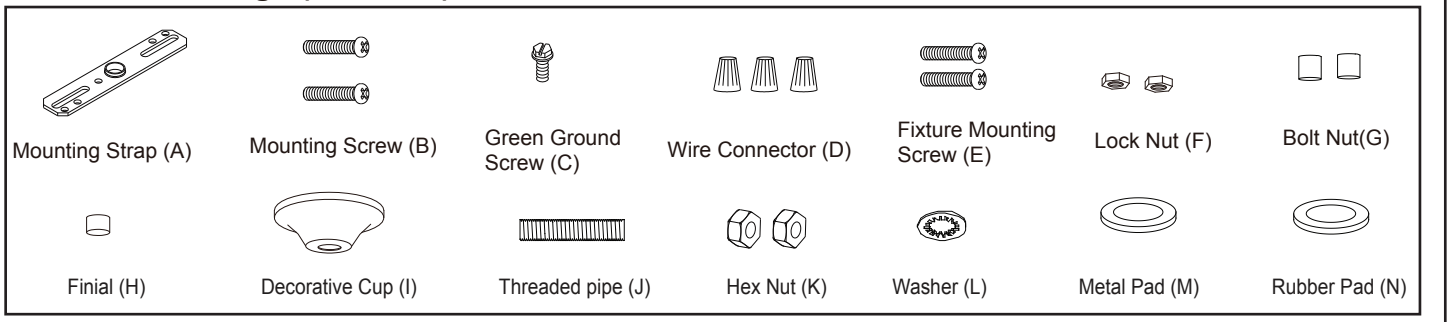

## Installation Steps

Turn off the power at fuse or circuit box.



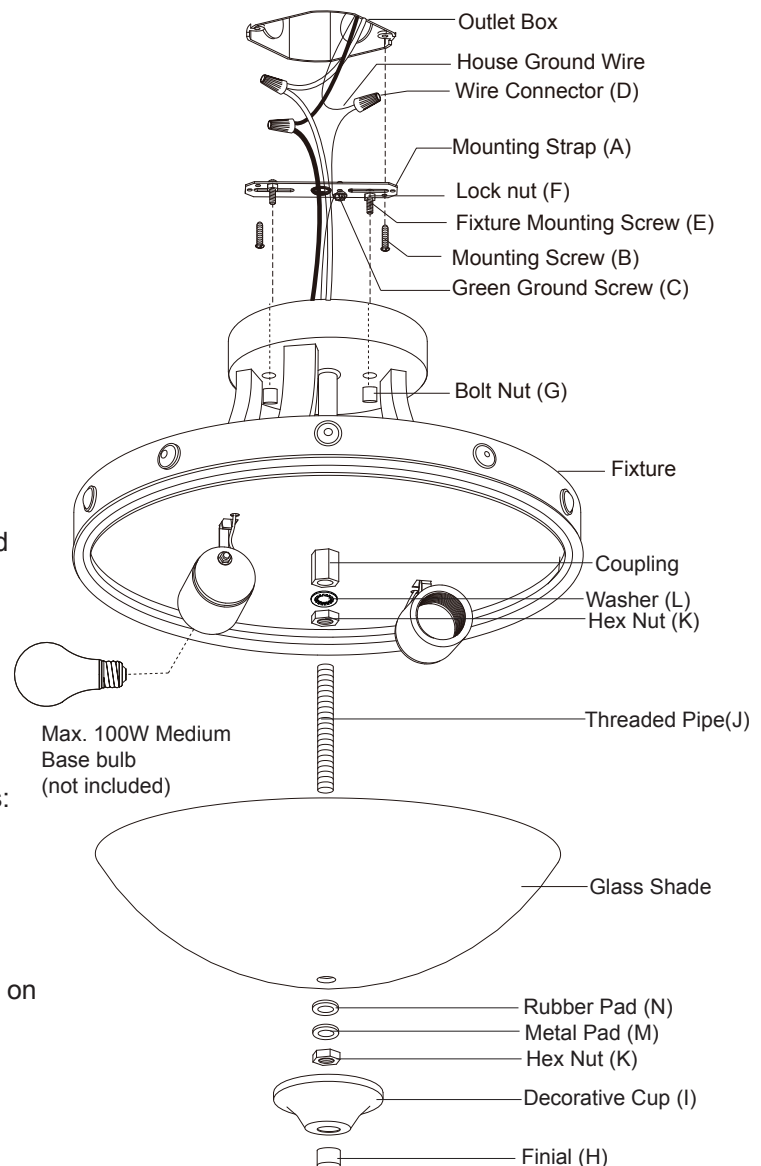







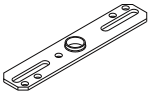



1. Attach the mounting strap (A) to the outlet box by using two mounting screws (B).
2. Screw the threaded pipe (J) into the coupling, then secure it with a washer (L) and hex nut (K).  
**NOTE: Depth of threaded pipe may need to be adjusted to properly fit glass shade, decorative cup and finial.**
3. Install 2 x 100W Max medium base bulbs (not included). See relamping label at socket area or packaging for maximum wattage allowed.
4. Attach the glass shade to the fixture by inserting the threaded pipe (J), then secure it with a rubber pad (N), metal pad (M) and hex nut (K).
5. Slip the decorative cup (I) up through the threaded pipe (J), secure it with the finial (H).
6. Pull out the source wires from the outlet box. Make wire connections using wire connectors (D) as follows:
  - Connect the hot wire (black insulation) from the fixture to the black wire from the power source.
  - Connect the neutral wire (white insulation) from the fixture to the white wire from the power source.
  - Attach the fixture ground wire (bare wire) to the mounting strap (A) with the green ground screw (C), then depending on local code, connect it to the house ground wire with the wire connector (D).
 Carefully put all of the wires back into the outlet box.
7. Attach the fixture to the mounting strap (A) by inserting two fixture mounting screws (E) then secure it with two bolt nuts (G).



Turn on the power at fuse or circuit box.

The following parts are available for reorder if damaged or missing.

**Spare Parts List:**

			
Mounting Strap (A)	Mounting Screw (B)	Green Ground Screw (C)	Wire Connector (D)
			
Fixture Mounting Screw (E)	Lock Nut (F)	Bolt Nut (G)	Finial (H)
			
Decorative Cup (I)	Threaded pipe (J)	Hex Nut (K)	Washer (L)
			
Metal Pad (M)	Rubber Pad (N)		

**Assembly Kit  
5213MM(1 SET)**

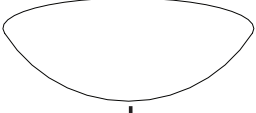
  
 ↓  
**Glass Shade  
9673CC (1 PC)**

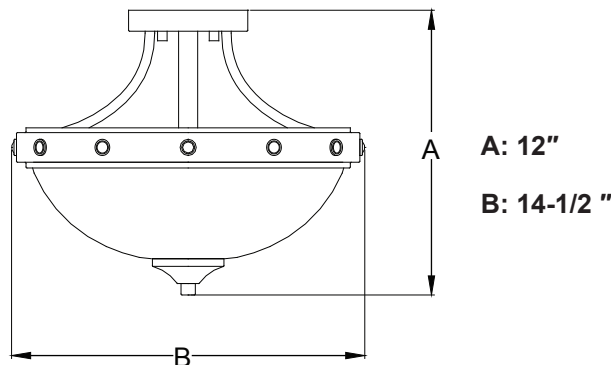

**1 Year Warranty**

Vaxcel warrants all of our products against defects in workmanship and finishes for one year following the date of shipment.

*Exclusions: This warranty does not include the failure of products from extreme acts of nature; environmental conditions not suited for the products intended use; operation in temperatures outside of the range specified in the instruction manual; usage with improper power supply, power surges or dips. For coastal locations, some corrosion is considered normal for the environment.*

*Vaxcel reserves the right to repair, replace or issue a credit for any properly installed product, provided it is returned per RMA instruction. This warranty is limited to the cost of the product only and does not extend to transportation, installation or replacement costs.*

How can warranty service be obtained?

info@vaxcel.com  
1-800-482-9235