

ASSEMBLY AND INSTALLATION INSTRUCTIONS

C0169

WARNING: TO AVOID RISK OF ELECTRICAL SHOCK, BE SURE TO SHUT OFF POWER BEFORE INSTALLING OR SERVICING THIS FIXTURE.

NOTES: 1. Before installing, consult local electrical codes for wiring and grounding requirements.
2. READ AND SAVE THESE INSTRUCTIONS.

Hardware Package (included):

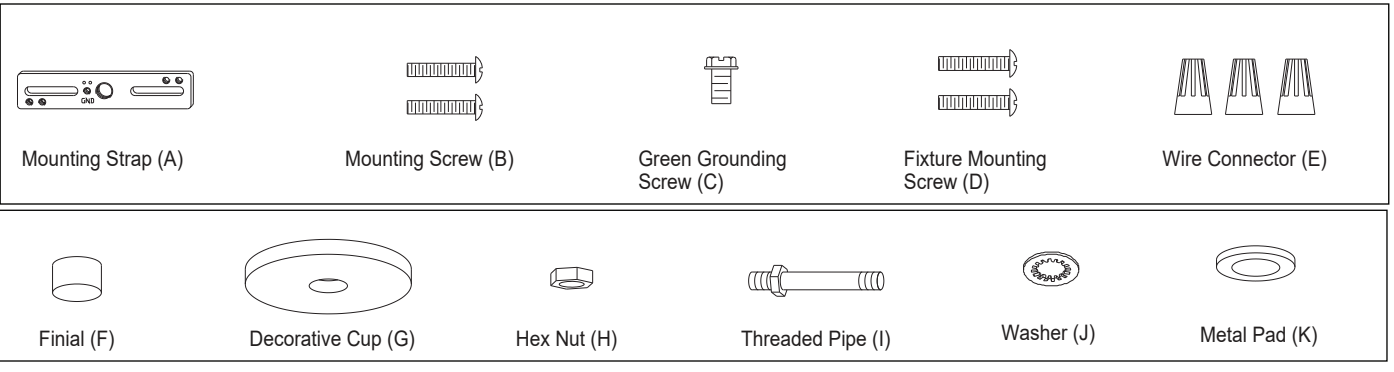

Installation Steps

Turn off the power at fuse or circuit box

1. Attach the two fixture mounting screws to the holes on the mounting strap, and screw them in 2 to 3 turns.
2. Attach the mounting strap to the outlet box using two mounting screws.
3. Pull out the source wires from the outlet box. Make wire connections using wire connectors as follows:
 - Connect the hot wire (usually black insulation) from the fixture to the black wire from the power source.
 - Connect the neutral wire (usually white insulation) from the fixture to the white wire from the power source.
 - Attach the fixture grounding wire (usually green insulation or bare wire) to the mounting plate with the green grounding screw, and then connect it to the house grounding wire with the wire connector.
 Carefully put the wires back into the outlet box.
4. Attach the ceiling pan to the mounting strap by inserting two fixture mounting screw heads into the key holes, and rotate the pan until it locks in place. Then secure the screws tightly.
5. Screw the threaded pipe into the coupling, then secure it with a washer and hex nut.

Note: Depth of threaded pipe may need to be adjusted to properly fit glass shade, decorative cup and finial.
6. Install 2 x 60W max medium base bulbs (not included) to the sockets.

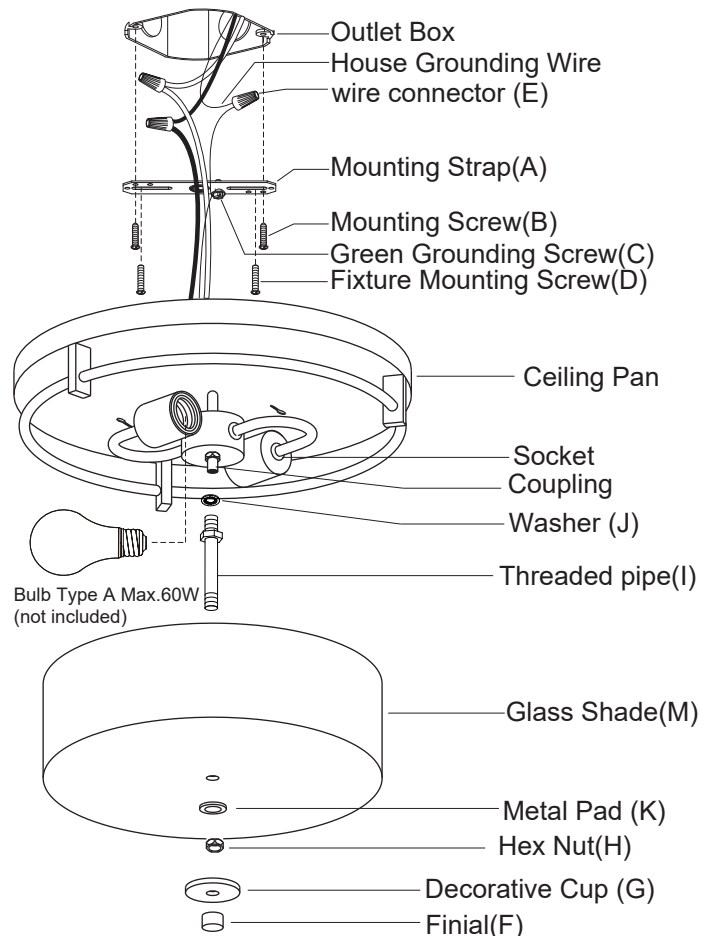

7. Slip the glass shade through the threaded pipe and upward the ceiling pan. Then tighten them with the metal pad and hex nut.











Caution: Do not over tighten, breakage of glass shade could be occurred.

8. Slip the decorative cup up through the threaded pipe, secure it with a finial.

Turn on the power at fuse or circuit box

The following parts are available for re-order if damaged or missing.

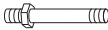
Spare Parts List:

					
Mounting Strap (A)	Mounting Screw (B)	Green Grounding Screw (C)	Fixture Mounting Screw (D)	Wire Connector (E)	
					
Finial (F)	Decorative Cup (G)	Hex Nut (H)	Threaded Pipe (I)	Washer (J)	Metal Pad (K)

Mounting Hardware 5770MM (1SET)

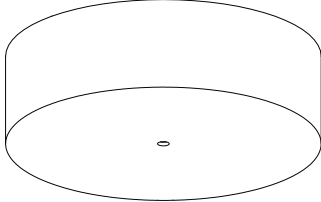
 → Glass Shade 9917CS

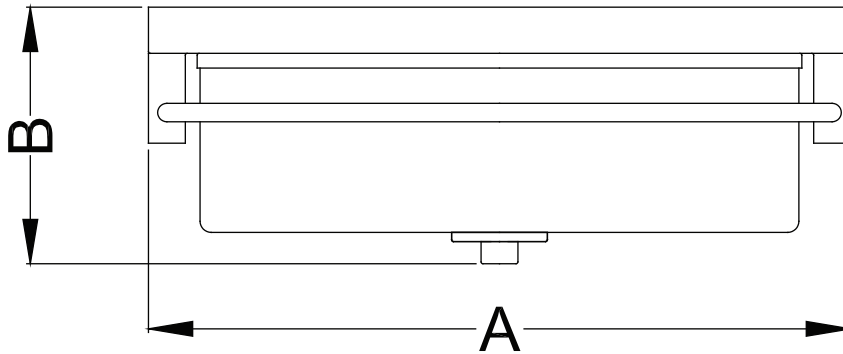

A: 15"

B: 5-1/2"

1 Year Warranty

Vaxcel warrants all of our products against defects in workmanship and finishes for one year following the date of shipment.

Exclusions: This warranty does not include the failure of products from extreme acts of nature; environmental conditions not suited for the products intended use; operation in temperatures outside of the range specified in the instruction manual; usage with improper power supply, power surges or dips. For coastal locations, some corrosion is considered normal for the environment.

Vaxcel reserves the right to repair, replace or issue a credit for any properly installed product, provided it is returned per RMA instruction. This warranty is limited to the cost of the product only and does not extend to transportation, installation or replacement costs.

How can warranty service be obtained?

info@vaxcel.com

1-800-482-9235